

**REQUEST FOR MATERIAL BID (“RFMB”)
AVCP VILLAGE PUBLIC SAFETY PROGRAM 2023 MATERIAL ORDER
RFMB CLOSES 4:00 P.M. AKDT ON MARCH 31, 2023**

THE ASSOCIATION OF VILLAGE COUNCIL PRESIDENTS (“AVCP”) is soliciting proposals for its VPSO Program for construction material and delivery for the Alakanuk Public Safety Building Project.

IMPORTANT DATES TO REMEMBER:

Deadline for Questions:	March 21, 2023
Bid Closing Date/Time Bids must be received by:	4:00 P.M. AKDT on March 31, 2023

GENERAL INFORMATION:

AVCP is soliciting Bids for obtaining construction materials and delivery to Alakanuk for the Alakanuk Public Safety Building Project in the FY 23 Barging Season

A. Primary Contacts

All questions, comments, must be directed and mailed/faxed/email to:

AVCP
ATTN: MICHELE CHASE - Procurement Coordinator
PO Box 219
Bethel, AK 99559-0219
Phone: (907) 543-7332 _____
Email: mchase1@avcp.org/procurement@avcp.org _____

All bids must be sent to:

ATTN: MICHELE CHASE - Procurement Coordinator
PO Box 219
Bethel, AK 99559-0219
Phone: (907) 543-7332 _____
Email: mchase1@avcp.org/procurement@avcp.org _____

B. Bid Documents

Bid Documents shall include all information contained in this RFMB, any additional information supplied by AVCP, and any addenda issued prior to bid closure.

Addenda are written or graphic instruments issued by AVCP prior to the bid closure which modify or interpret the Services Bid Documents by additions, deletions, clarification of Respondents’ question or corrections.

C. Respondent’s Representation

The Respondent, by submitting a bid, represents that the Respondent is familiar with the services requested and all requirements of this RFMB, including all appendices.

D. Solicitation Review

Respondents should carefully review this solicitation, without delay, for omitted information or ambiguity. Part, or all, of any bid may become an integral part of any contract arising from this solicitation. Furthermore, any contract arising from this solicitation shall not be limited by any matter stated in this solicitation or the successful proposal. The contract formed after receipt of a bid may include additional terms and conditions. AVCP reserves the right to make use of any idea or matter made a part of any bid submitted in response to this solicitation. The right to use any idea or matter made a part of any proposal shall not be limited by AVCP acceptance or rejection of the bid containing such idea or matter.

E. Reply to Questions or Comments regarding this Solicitation

At its discretion, AVCP shall choose whether or not to respond to particular questions or comments about this solicitation from Respondents. Additionally, AVCP may at its discretion provide responses to questions or comments to all Respondents or may reply only to the Respondent who submitted the question or comment. All questions must be received in writing ten (10) business days prior to the bid closing to be considered.

F. Amendments to this Solicitation

In the event it becomes necessary to revise any part of this solicitation, a copy of the revision shall be sent to each Respondent who shall timely acknowledge receipt of the original solicitation and advise AVCP of their intention to submit a proposal.

G. Submission Date

To be considered, the Respondent's bid must be received by the primary contact identified above no later than **4:00 P.M. AKDT on March 31, 2023**. Email proposals are accepted in PDF format. Bids may be modified until **4:00 P.M. AKDT on March 31, 2023**, by email or in person.

H. Right of Rejection or Cancellation

AVCP reserves the right to reject any and all bids/proposals and to waive any and all stated requirements relative to bids/proposals. AVCP reserves the right to cancel this solicitation at any time before the submittal deadline.

I. Respondent Costs

Any and all costs incurred by each Respondent in connection with the preparation and submission of a bid, including but not limited to travel expenses, shall be the sole responsibility of the Respondent and will not be reimbursed by AVCP.

J. Disclosure of Proposal Contents

AVCP will review bids submitted in such a manner as to avoid disclosure of content to competing Respondents. Nevertheless, all proposals and other material submitted in support of any bid shall become, upon receipt by AVCP, property of AVCP, and AVCP reserves the right to use any idea or any other matter contained in any proposal or any material accompanying the bids regardless of whether or not the proposal is accepted by AVCP.

K. Respondent's Certificate

By submission of a bid, a Respondent is certifying to AVCP that it is not colluding with any other Respondent. AVCP will be privileged upon discovery that such certificate is false to reject the bid or terminate any contract to which it is a party arising from the proposal.

L. Information about the Association of Village Council Presidents

AVCP is a Native non-profit corporation operating under the pertinent laws and regulations of the State of Alaska and the United States. AVCP provides governmental programs to its 56 member Tribes, which are located throughout southwest Alaska. AVCP is located in Bethel, Alaska.

M. Minimum Respondent Qualifications

1. No Joint Ventures

AVCP will not enter into a contract with a joint venture for the services made a subject of this solicitation. Nor will AVCP enter into more than one contract to obtain all of the services made a subject of this solicitation.

2. Financial Condition

AVCP will not contract with any Respondent whose financial condition is not satisfactory to AVCP.

3. Business and Insurance License

AVCP will not enter into any contract with any Respondent who is not the holder of a current business license.

4. EEO Policy

AVCP will not enter into any contract with any Respondent who has been debarred from Government contracts pursuant to Executive Order 11246. AVCP will not enter into any contract with any Respondent who will not expressly, in writing, undertake to abide by every applicable law governing equal employment opportunity. Any contract arising from any bid made in response to this request, and any subcontract, will include any term(s) respecting the same matters as is prescribed by such law(s).

5. Minimum Privacy and Confidentiality Standards

AVCP will not contract with any Respondent who will not expressly, in writing, agree to adhere to AVCP standards in connection with privacy of AVCP confidential information and the information of its participating employers.

N. Standard Contract Information

2. Written Contract

To be enforceable, any contract arising from this solicitation must be stated in writing, signed by the parties. It will expressly provide that it is, and is intended to be, a complete statement of the entire agreement of the parties and shall include a description of duties, obligations and responsibilities of the parties providing assurances of performance, reliability, security, confidentiality, and reporting requirements. If any Respondent will require that a written contract with AVCP be in a particular form, or that such a contract contain a particular written provision, such writing should be included as part of the Respondent's bid.

Any or all of any bid may become an integral part of any contract arising from this solicitation. Furthermore, any contract arising from this solicitation shall not be limited by any matter stated in this solicitation or the successful bid. The contract formed after receipt of a proposal may include additional terms and conditions.

3. Indemnification

The successful Respondent will, as a part of any contract arising from this solicitation, be required to expressly, in writing, indemnify, save harmless and defend AVCP, its officers, agents and participants from all liability, including costs and expenses, for all actions or claims resulting from injuries or damages (including, without limitation, solely economic damages), sustained by any person or property arising directly or indirectly as a result of any error, omission or negligent act of the successful Respondent, a sub-contractor, or anyone directly or indirectly employed by them in the performance of any portion of any contract arising from this solicitation. Any proposal submitted, to be considered by AVCP must be accompanied by evidence satisfactory to AVCP of Respondent's ability to perform such an undertaking.

4. Payment

AVCP will pay by check for services performed under any contract arising from this bid. The supplier will submit invoices, detailing materials accepted. AVCP shall pay an approved invoice within twenty (20) working days of approval. AVCP will not undertake to pay any tax arising from the transaction whatsoever.

5. Prime Contractor Responsibilities

As part of any contract arising from this solicitation, the successful Respondent will be required to assume responsibility for all services to be furnished whether they are furnished by the successful Respondent or a subcontractor. Furthermore, the successful Respondent will be the only party other than AVCP that is a party to the contract; the only one with whom AVCP will engage in communication respecting matters related to performance under the contract; and the only one to whom any payment required of AVCP under the contract will be made.

6. No Assignment

Any contract arising from this solicitation will expressly bar the successful Respondent's assignment of the contract or any of such Respondent's rights under the contract, without the prior written consent of AVCP; and expressly provide, in substance, that any purported assignment or transfer without such prior written consent will be void and without force or effect. However, Respondent understands that AVCP shall be permitted to assign the contract or any AVCP rights under the contract.

7. Contract Term

The term of the proposed contract shall commence on or after acceptance of bid and the signing of a written agreement and terminate based on material acceptance. Further extensions will be at the discretion of AVCP.

8. Material Delivery

All Materials shall be delivered to the designated locations in each of the respective communities. It is the intent of AVCP that the materials will be delivered in accordance with AVCP's delivery schedule. AVCP will accept the conforming materials based on completion of the joint inspection as described in 10 Inspection. All materials are to be delivered in the 2023 barging season.

9. Liquidated Damages

Liquidated damages in the amount of three thousand five hundred dollars and zero cents (\$3,500.00) per calendar day for delay will be assessed for missing the material delivery schedule, barring any weather delays and/or other events of force majeure (as defined in the final contract). Extensions may be granted at AVCP's sole discretion; AVCP may deny requests for extensions for any reason.

10. Inspection

Respondent shall provide an authorized representative at the Delivery Site to meet with an AVCP representative. Representatives from both parties shall inventory and assess the Materials for damage prior to AVCP's acceptance.

O. Minority Owned Business Enterprise/Women Owned Business Enterprise

If Respondent is asserting Minority Owned Business Enterprise/Women Owned Business Enterprise eligibility or claiming an Alaska Native/American Indian owned business status, provide documentation. AVCP, in accordance with the provisions of Title VI of the Civil Rights Act of 1964 (78 Stat. 252, 42 U.S.C. §§ 2000d to 2000d-4) and the Regulations, hereby notifies all bidders that it will affirmatively ensure that any contract entered into pursuant to this advertisement, disadvantaged business enterprises will be afforded full and fair opportunity to submit bids in response to this invitation and will not be discriminated against on the grounds of race, color, or national origin in consideration for an award.

P. AVCP Furnished Items

AVCP will provide a contact person to coordinate these services.

Q. Respondent Furnished Items

Respondent shall provide materials as set forth in the Scope of Work outlined in Appendix A. "Partial bids" (i.e. bids for some, but not all, of the materials set forth in Appendix B will be accepted. However, bids/respondents who can provide all materials in the Scope of Work will be considered most advantageous to AVCP.

R. Preparation of Bid.

Bids shall only be submitted on the forms or legible copies of the Association of Village Council Presidents' forms (Appendix A). All entries shall be legible and in ink or type. Respondents are required to provide an email address on the bid form.

The bid must be signed in ink by the person or persons authorized to sign the Contract for the bidder. If a bidder is a corporation, the bid must be signed by a corporate officer with authority to bind the corporation. If a bidder is a partnership, a partner must sign. Each person signing the bid must initial any changes made to entries on the bid forms.

S. Non-Responsive Bids

A bid shall be rejected as nonresponsive if it:

1. Does not conform to the requirements of Paragraph 'R' above;
2. Is not properly signed by an authorized representative of the bidder in ink and in a legally binding manner;
3. Contains unauthorized additions, conditional or alternative bids, or other irregularities that make the bid incomplete, indefinite, or ambiguous;
4. Includes a reservation of the right to accept or reject any award, or to enter into a contract pursuant to an award;
5. Fails to include shipping in the bid cost for each bid category;
6. Fails to meet any other material requirement of the Request for Material Bid;
7. Is materially unbalanced; or
8. A bid may be rejected as nonresponsive, in the Association of Village Council Presidents' discretion, if it:
 - a. Is not typed or completed in ink;
 - b. Fails to include an acknowledgement of receipt of each addendum by assigned number and date of issue; or
 - c. Is missing a bid price for any pay item, except when alternate pay items are authorized.

T. Draft Contract

Respondent's form of proposal may be accompanied by a proposed form of written contract. Respondent's proposal should be accompanied by a complete written statement of any contract term that, according to Respondent, must be a term of any contract it makes with AVCP arising from this solicitation.

U. Confidentiality of the Association of Village Council Presidents Information

Information supplied by AVCP to Respondent in connection with this request for proposal is the confidential information of AVCP. Respondent and its employees and agents shall protect the confidentiality of AVCP furnished information and prevent its use and disclosure.

V. Or equal review

Respondents that intend to submit product(s) that are equal to those specified in the RFMB are encouraged to submit them for review prior to submitting a bid. A Respondent should assume a minimum review time of 10 business days for a determination whether a product is considered an equal.

W. Receipt and Opening of Bids

AVCP will only consider bids, revisions, and withdrawals received before the scheduled time of bid receipt.

AVCP is not responsible for prematurely opening or failing to open bids that are improperly addressed or identified.

Unofficial results shall be provided within four (4) days of opening.

- X. Compliance with 23 CFR 635.410 – Buy America Act**
Bidders shall complete and submit Appendix “C” – Buy America Certification, with all submitted bids, if applicable. Those bids that fail to include this certification will be deemed as nonresponsive in accordance with paragraph “S.”
- Y. Davis Bacon Wage Rates:** Contractor shall comply with and shall require its subcontractors to comply with the Davis-Bacon Act (40 U.S.C. 276a to a-7), as supplemented by Department of Labor regulations (29 CFR part 5). AVCP requires the use of Form WH-347 for mandatory Davis Bacon reporting.
- Z. Federal Aid-Construction Contract Requirements:** Contractor shall comply with all applicable required contract provisions for federal-aid construction contracts found at:
<https://www.fhwa.dot.gov/programadmin/contracts/1273/1273.pdf>.
- AA. Evaluation**
AVCP will evaluate bids based on cost as well as a scheduling. AVCP will select the Respondent(s) that best meet the needs of AVCP.
- BB. Withdrawal or Revision of Bids**
Bidders may withdraw a bid in writing delivered by mail, by email in PDF format, or in person, provided that the designated office receives the withdrawal or revision before the time set for opening of bids. All revisions must be received by the bid closing date and time.

APPENDIX A
AVCP TRANSPORTATION DEPARTMENT BID SHEET
AVCP VPSO Department 2023 MATERIAL ORDER

Description of Materials: _____

To: The Association of Village Council Presidents ("Owner"):

The undersigned, having familiarized him/herself with the local conditions and federal, state, or local requirements affecting the cost of the work, and with the Specifications including information present in the Request for Materials Bid, this Bid, the Form of Contract, the Scope of Work, the attached Exhibits, and Addenda, in any thereto, hereby proposes to furnish all, materials as described in the following:

Description of Materials

All in accordance therewith, for the lump sum of:

BID: _____ Dollars (\$ _____)

The work shall commence at the time stipulated in the Notice to Proceed and shall be substantially complete as defined in the Contract.

In submitting this bid, it is understood that the right is reserved by AVCP to reject any and all bids. If written notice of the acceptance of this bid is mailed, telegraphed or delivered to the undersigned within forty five (45) days after the opening of this bid, or any time thereafter before this bid is withdrawn, the undersigned agrees to execute and deliver a Contract in the prescribed form to the undersigned for signature.

The Undersigned declares, under penalty of perjury under the laws of the United States, that neither s/he or the firm, association, or corporation of which s/he is a member, has, either directly or indirectly, entered into any agreement, participated in any collusion, or otherwise taken any action in restraint of free competitive bidding in connection with this bid.

The undersigned further acknowledges receipt of the following Addenda:

ADDENDUM NO. _____ DATED _____, 2020

COMPANY: _____

ADDRESS: _____

FAX: _____ EMAIL: _____

NAME: _____ TITLE: _____

SIGNATURE: _____ DATE: _____

APPENDIX B
ALAKANUK PUBLIC SAFETY BUILDING MATERIALS DESCRIPTION:

Public Safety Building SOW for RFP.

MATERIALS AND DELIVERY TO ALAKANUK IN 2023 BARGING SEASON.

Scope of work – Material Purchase and delivery for a 40 x 50, 2000 Sq. public safety building. Standard 8' walls. Delivery to ALAKANUK, 2023 barging season.

Floor configuration: See draft diagram for general indication drawings. Vendor will be required to submit complete prints including electrical, plumbing, and mechanical. Roughly half the building, area A, is to be the space of 5 separate holding cells, with an entrance/staging area and bathroom. This entire area is to be participation off from the rest of the floor space. Area B, another half of floor space is to consist of front and back door. Another bathroom backed up against the bathroom inside the holding cell area. Two offices, labeled, VPO/TPO office, VPSO office and Fire safety/SAR, with an outside entrance. Building will be heated with two Toyo stoves of sufficient btu for 20000 sq space in local climate conditions. Rough floor plan to be modified to accommodate venting for Toyo stoves. Two fuel tanks, stands, and required pumps and connections. Floor will be min of 6' above ground to accommodate Alakanuk locally accepted building, flood considerations.

Building is to be a Prefab panel construction, detail plans and construction documents, and materials. Complete plumbing and electrical system to be included. Plans will include plumbing.

PLANS: SCALE ¼" = 1' – 0"

FRONT ELEVATION	CONSIDERATIONS.
RIGHT ELEVATION	FRAMING PLAN
LEFT ELEVATION	JOIST FRAMING DETAIL
REAR ELEVATION	END JOIST CONNECTION
FLOOR PLAN	CANT. DECK (TYP)
PLUMBING	RAISED FLOOR FRAMING
ELECTRICAL	STAIRS DETIALS
MECHANICAL	JOIST ATTACHEMENT
FOUNDATION PLAN, POST AND PAD	STRAP CONNECTIONS
FRONT PERSPECIVE	GABLE WIND BAFFLE
ISOMETRIC PERSPECTIVE	BARGE/SOFFIT DETAIL – TYP.
FOOTING SCHEDULE	HEEL DETAIL (TYP.)
X-BRACING TYP.	
POST/BEAM CONNECTION	ROOF FRAMING PLAN
POST BASE BRACKET	GABLE TRUSS CONNECTION
POST CAP BRACKET	TRUSS TYPE
BOTTOM OF FLOOR MIN 6' ABOVE	SHEARWALL DESIGN VALUES (Hem- Fir, ESR
GROUND TO ACCOMMODATE ALAKANUK	1539)
LOCALLY ACCEPTED BUILDING PRATICE. FLOOD	

STRUCTURAL NOTES:

SOILS:

1. ALLOWABLE BERING STRENGTH ASSUMED TO BE 150PSI, WTH 33% INCREASE FOR SISMIC OR WIND LOADS.

WOOD:

1. FRAMING LUNBER ASSUMED HEM-FIR, #2 OR BETTER:
2. TRUSS LUMBER ASSUMED TO BE TRUSS GRADE
3. BLOCKING NOT REQUIRED ROOF/FLOOR DIAPHRAGM UNLESS OTHERWISE NOTED.
BOUNDARY NAIL FLOORS AT 4" O.C. PANEL EDGES. AT 4" O.C. AND FIELD AT 12" O.C.
4. SHEER WALL/ROOF DIAPHRAGM STAPLING/NAILING SPECIFIED REFERS TO PANEL EDGE AND BOUNDARIES; FIELD FASTENED AT 12" O.C., FLOORS AND WALLS. FIELD FASTEN ROOFS AT 8" O.C. UNO.
5. MULTIPLE STUD SPLICES-USE TWO TOWS 16d COM. @ 6" O.C. MIN
6. MULTIPLE LVL-SPLICES W/2 ROWS 16d COM. @ 6" O.C., 2" FROM TOP AND 2" FROM BOTTOM
7. 3" BOUNDARY MEMBERS REQUIRED AND STAPLES/NAILES SHALL BE STAGGERED WHERE SPACING IS LESS THAN 3" O.C., AND WHERE 10d NAILS PENETRATING MORE THAN 1-5/8" ARE PLACED AT 3" OR LESS O.C. DOUBLE STUDS NAILED WITH 16d. @ 4" O.C. MAY SUBSTITUE FOR 3" MEMBERS.
8. GLULIAM MEMBERS: SINGLE SPAN-RATED 24F-V4, DF/DF: MULTIPLE SPAN-RATED 24F-V8, DF/DF.
9. APA RATED SHEETING REQUIRED FOR SHEER WALLS, FLOOR AND ROOF DIAPHARAGMS. WALLS SHEETING MAY BE INSTALLED HORIZONTALLY OR VERTIALLY. IF INSTALLED HORIZONTALLY, BLOCK ALL PANEL EDGES.
10. WHERE T1-11 SIDING IS USED FOR SHEAR SHEATING, MINIMUM THICKNESS SHALL BE 19/32". ALL NAILING MUST BE THROUGHT FULL THICKNESS. BLOCK ALL JONTS IF FUL HEIGHT SIDING IS NOT USED.
11. FASTNER & DAPHRAGM VALUES PER IBC 2006, CORRECTED FOR HEM-FIR.
12. PLYWOOD MAY BE SUBSTITUTED FOR OSB, SAME THICKNESS, SAME APA RATING.
13. USE APA RATED SHEETING AS FOLLOWS, UNLESS NOTED OTHERWISE:
SHEER WALLS AND ROOFS, NON- DRIFT AREAS 24/16
ROOFS, VALLERS AND UPPER DRIFT AREAS 24/16
ROOFS, BELOW UPPER ROOFS AND WHERE WALL CAUSING DRIFT IS 6' OR HIGHER 40/20
14. 8d NAILS CAN BE SUBSTITUTED FOR 14GA. STAPLES, UNLESS NOTED OTHERWISE.
15. ANCHOR BOLTS PER SCHEDULE: ALL ELSE IBC MIMIMUM 5/8"x12" W/3"x3"x1/4" PLATE WASHER @ 4' O.C.
16. HOLDOWNS & ANCHOR BOLTS SHOWN ARE SIMPSON OR AS APPROVED BY MOA.
17. HOLDOWNS VALUES PER SIMPSON HEM-FIR TABLES.
18. GWB PER IBC MINIMUM: NOT USED FOR SHEAR
19. HANGERS, STRAPS, SADDLES, AND OTHER HARDWARE ARE AS MANUFACTURED BY SIMPSON STRONGTIE. VALUES ARE CORRECTED FOR HIM-FIR AS REQUIRED.

STEEL:

1. PLATE CHANNEL, ANGLE – ASTM (American society of testing materials) A36: WIDE FLANGE – ASTM A992, GR 50
2. ANCHOR BOLTS AND MACHINE BOLTS – ASTM A307, UNO.
3. HSS – [ROUND, SQUARE, RECTANGULAR SECTIONS] ASTM A500 GRADE F, = 46 KSI

DOOR SCHEDULE SPEC

EXTERIOR DOORS, FIBERGLASS. COLONAL 6 PANEL

INTERIOR OFFICE DOORS, HOLLOW CORE. COLONAL 6 PANEL.

CELL DOORS, SOLID CORE PREFINISH BRICH. W/METAL LIGHT COMMERCIAL METAL FRAME.

(TIMELY BRAND) VENTED AT BOTTOM. INCLUDE 6X27 SAFETY GLASS WINDOW.

WINDOW SCHEDULE SPEC

ALPINE 80 SERIES. STD HARDWARE.

GENERAL NOTES:

1. INSULATION (MIN VALUE) – ROOF (FLAT) R – 38. WALL R – 34. FLOOR R 47.
2. ALL EPOSED INSULATION IS TO HAVE A FLAME SPREAD RATING OF LESS THAN 25 AND A SMOKE DENSITY RATING OF LESS THAN 450 COVER ANY FOAM PLASTIC INSULATIO WITH ONE-HALF INCH GYPSUM BOARD OR PLYWOOD.
3. ALL EXTERIOR OPENING AND BERING WALL OPENINGS TO HAVE A 4 X 12 HEADER
4. PROVDE FIRE BLOCKING, DRAFT STOPS AND FIRE STOPS AS PER IBC 2009
5. EACH OFFICE TO HAVE MINIUUM WINDOW OPENING OF 5.7 SQ FT. WITH A MIN WIDTH OF 20" AND MINU HEIGHTS OF 24", AND A SILL LESS THAN 44" INCHES OFF THE FLOOR.
6. ALL WINDOWS WITHIN 18" OF THE FLOOR OR WITHIN 24" OF ANY DOOR NEED TO BE TEMPERED GLASS
7. IF TUB OR SHOWER HAS AN ENCLOSURE, IT MUST E GLAZED W/SAFETY GLAZING
8. ALL EXTERIOR WINDOWS ARE TO BE DOUBLE INSULATED GLASS AND ALL ETERIOR DOORS ARE TO BE SOLID CORE WOOD OR INSULATED FIBERGLASS W/WEATHER STRIPP9NG. PROVIDE ½" DEAD BOLT LOCK ON ALL EXTERIOR DOORS AND LOCKING DEVICES ON ALL DOORS OR WINDOWS WITHIN 10" (VERTICAL) FEET OF GRADE.
9. LOCATE SMOKE/CARBON MONOZIDE DETECTORS IN EACH OFFICE AND CELL AND OUTSIDE OF EACH SEPARATE SPACE IN THE IMMEDIATE VICINITY OF OFFICES AND HOLDING CELLS. CONNECT SMOKE DETECORS TO BUILDING ELECTRICAL SYSTEM W/BATTERY BACKUP AND INTERCONNECT EACH ONE SO THAT WHEN ONE IS TRIPED THEY WILL ALL SOUND.
10. CELLS ARE TO BE LINED WITH 5/8 CDX PLYWOOD COVERED WITH SMOOTH 3/15 RFP BOARD, or similar.
11. ALL OUTLETS IN BATHROOMS, AND OUTLET ACCESSIBLE FROM OUTSIDE SHALL BE GFCI PROTETED.
12. BATHROOMS AND UTILIY ROOMS ARE TO BE BENTED TO THE OUTSIDE WITH A MINIMUM OF A 90 CFM FAT. SCREW ALL DUCTWORK TOGHTER AND SEAL WITH DUCT TUBE OR SILICONE SEALANT USE 3 SCREWS AT EACH JOINT.
13. ALL TRUSSES HAVE A 11-1/4 ARCTIC HEEL MIN.
14. WALL COVERINGS PANELING
15. CEILING COVERING ACOUSTIC TILE.
16. ELECTICAL CONDUCTORS IN UNFINISHED AREAS MUST BE PHYSICALLY PROTECTED.
17. ALL EXPOSED WOOD ON EXTERIOR OF THE BUIDING SHALL BE ROTECTED.
18. IF TILE IS USED BLOCKING ON EXTERIOR WALLS SHALL BE DENS-SHIELD
19. ALL EXTERIOR FAUCETS TO BE FROST FREE (ARCTIC FAUCET) WITH ANTI-SIPHON DEVICE
20. PROVIDE POSITVE CONNECTION AT BEAM POCKETS FOR BEAM GIRDERS AND HEADERS.
21. THE NET FREE VENTILATION, IF REQUIRED, TO BE 1/150 OF THE ENCLOSED AREA WITH HALF OF THE REQUIRED VENT 3 FEET ABOVE EAVE OR CORNICE VENTS (IRC) INTERNATIONAL RESIDENTIAL CODE.
22. ROOF COVERING IS TO BE METAL OF SUFFICIENT GUAGE AND HOLD DOWN AS PRESCRIBED BY IBC 2009 FOR THE BEHTEL REGION, AK.

DESIGN CRITERIA, IBC 2009

WIND – IBC 2009 FOR BETHEL REGION, AK

SEISMIC – IBC 2009 FOR BETHEL REGION, AK

SNOW – IBC 2009 FOR BEHTEL REGION, AK

LOADS – IBC 2009 FOR BETHEL REGION, AK

SOILS – IBC 2009 FOR BETHEL REGION, AK

LATERIAL LOAD RESISTING SYSTEM:

LIGHT FRAME WALLS WIH WOOD SHEAR PANNELS

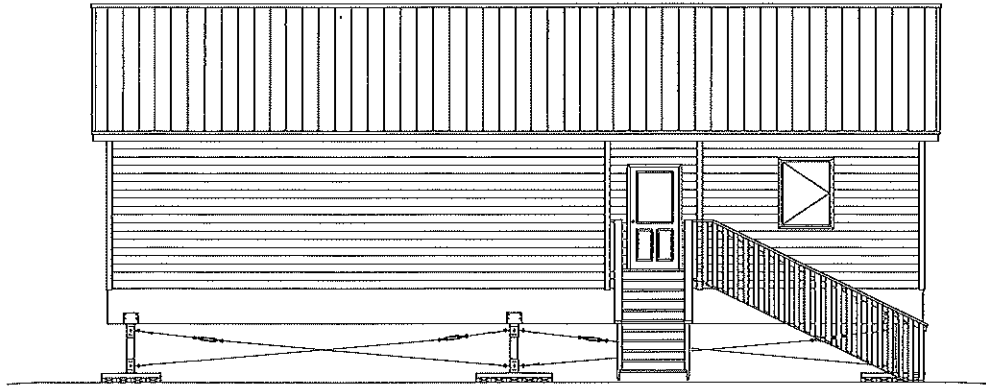

REAR ELEVATION
SCALE: 1/4"=1'-0"

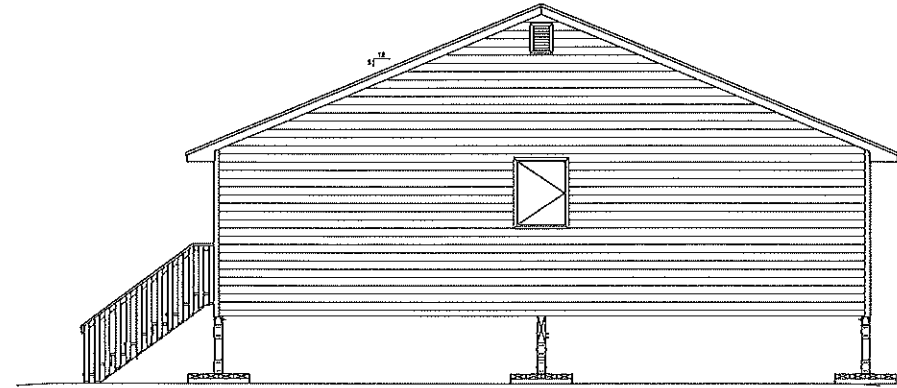

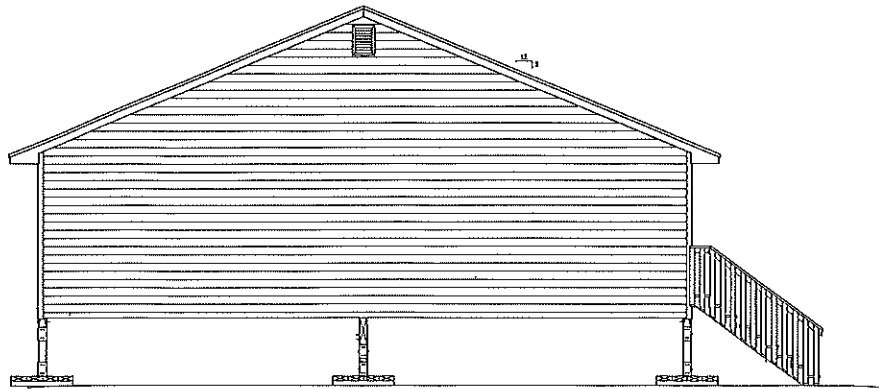

RIGHT ELEVATION
SCALE: 1/4"=1'-0"

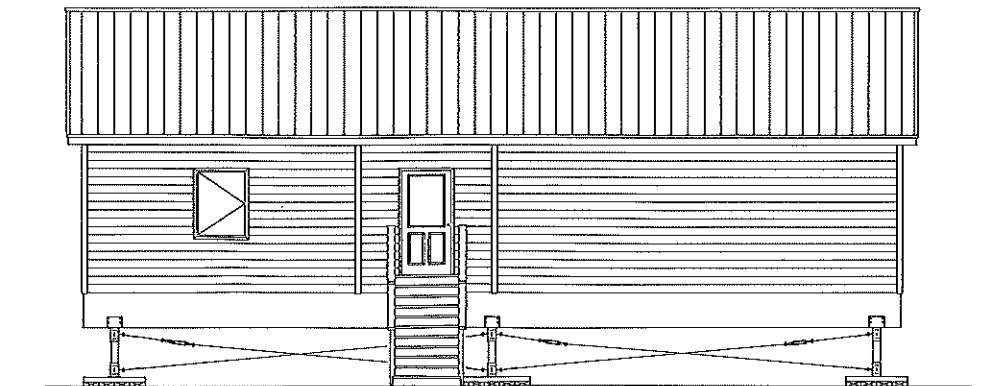

LEFT ELEVATION
SCALE: 1/4"=1'-0"



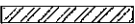

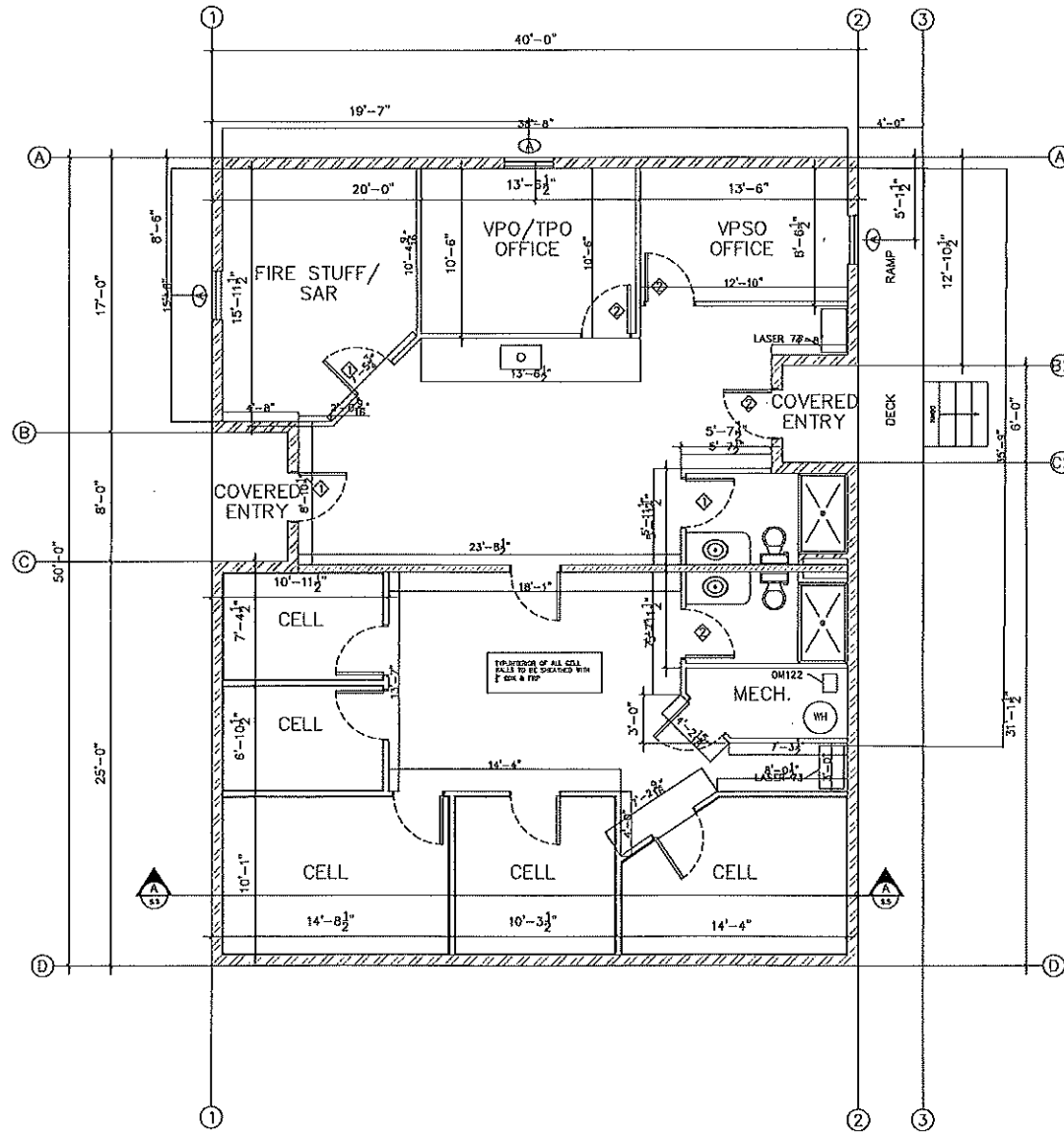

FRONT ELEVATION
SCALE: 1/4"=1'-0"

-  2X8 EXTERIOR
-  2x6 SEPARATION
-  1/2" CDX & FRP SHEATHING



WINDOW SCHEDULE					
DESCRIPTION	MANUFACTURER	SIZE	OPENING	MATERIAL	DESCRIPTION
(A)	ALUMI 60 SERIES	30"x48"	C	SP	

DOOR SCHEDULE						
DESCRIPTION	TYPE	WIDTH	HEIGHT	ROUGH OPENING	FINISH	DESCRIPTION
	20 IN. SOLID CORE	36"	80"	35"x81"-6"	URS	PREFABRICATED BRON
	20 IN. SOLID CORE	36"	80"	35"x81"-6"	URS	PREFABRICATED BRON
	GLASS	36"	80"	35"x81"-6"	URS	PREFABRICATED BRON
	FRAMGLASS	36"	80"	35"x81"-6"	URS	PREFABRICATED BRON

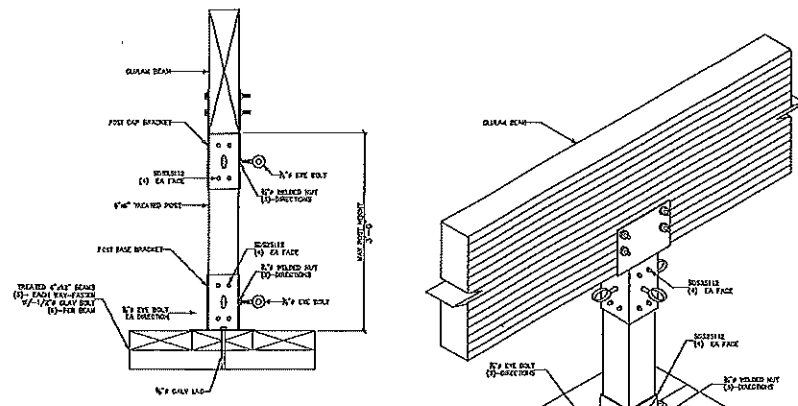

FRONT PERSPECTIVE

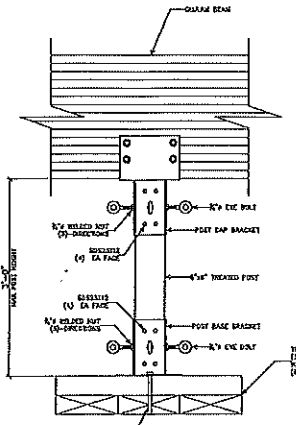

SIDE PERSPECTIVE

(A) POST/BEAM CONNECTION
SCALE: 1/4"=1'-0"

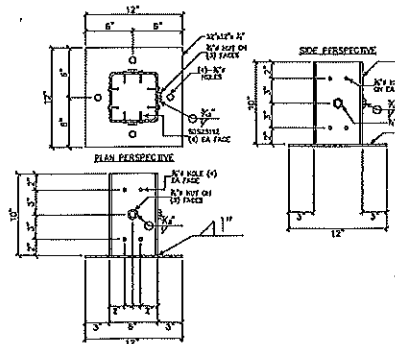

(C) POST BASE BRACKET
SCALE: 1/4"=1'-0"

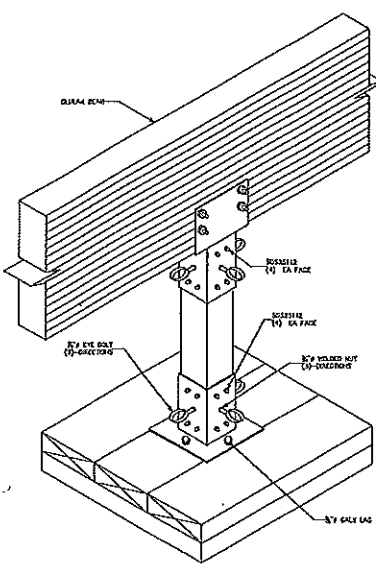

ISOMETRIC PERSPECTIVE

DESCRIPTION	FOOTING BOLT	FASTENING
	1/2" x 12" GALV LAG	(2) BOLTS PER HOLE
	1/2" x 12" GALV LAG	(2) BOLTS PER HOLE
	1/2" x 12" GALV LAG	(2) BOLTS PER HOLE

NOTES:
 1. FOOTINGS SHOWN AT 1/4" STAGE IN ALTERNATE DIRECTION FROM THIS PLAN.
 2. IF NOT SHOWN OTHERWISE, DIMENSIONS ARE IN FEET & INCHES. DOUBLE CHECK MEMBER SIZE AND SPACING THROUGH TOP/SECTION LATER.

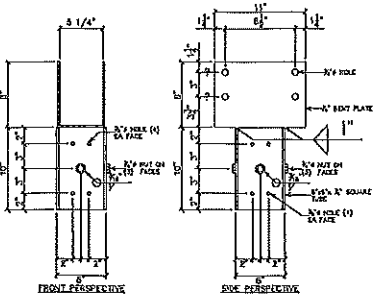

(D) POST CAP BRACKET
SCALE: 1/4"=1'-0"

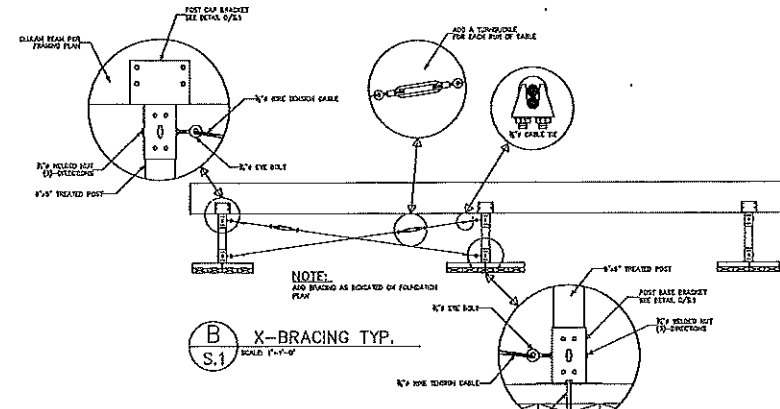

(B) X-BRACING TYP.
SCALE: 1/4"=1'-0"

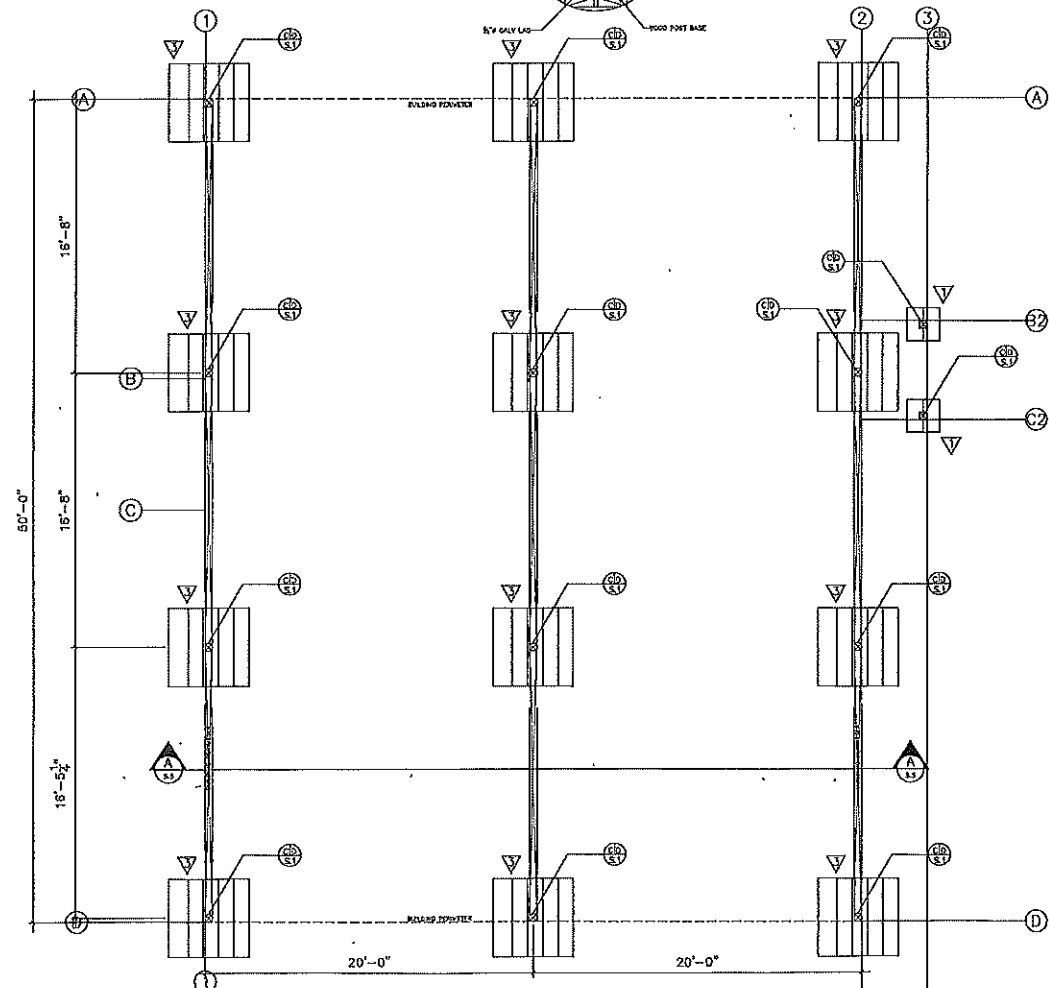

FOUNDATION PLAN
SCALE: 1/4"=1'-0"

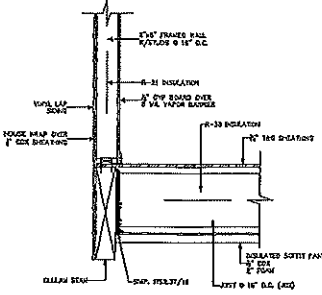

A JOIST FRAMING DETAIL
SCALE 3/8"=1'-0"

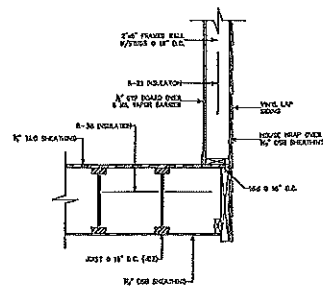

B JOIST FRAMING DETAIL
SCALE 3/8"=1'-0"

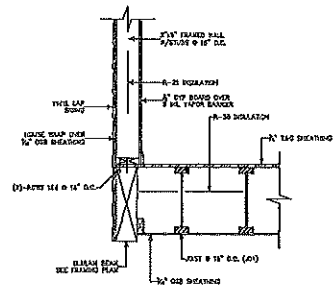

C JOIST FRAMING DETAIL
SCALE 3/8"=1'-0"

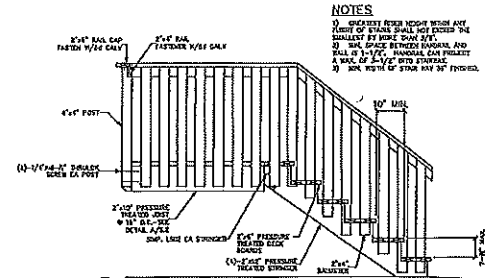

H STAIRS DETAILS
SCALE 1/2"=1'-0"

NOTES
 1) CHECK RISE AND RUN WITH ARCH.
 2) FINISH OF STAIR SHALL NOT EXCEED THE
 SHALLOWEST BY MORE THAN 3/8".
 3) RAIL SPACES BETWEEN HANDRAIL AND
 RAIL IS 1-1/2". HANDRAIL CAN PROJECT
 A MAX. OF 2-1/2" OVER STRINGER.
 4) RUN WIDTH OF STAIR MAY NOT EXCEED 4'-0".

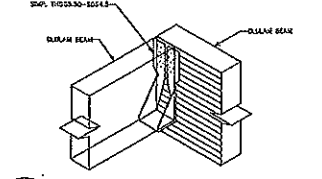

D BEAM CONNECTION-GRID 2
SCALE 3/8"=1'-0"

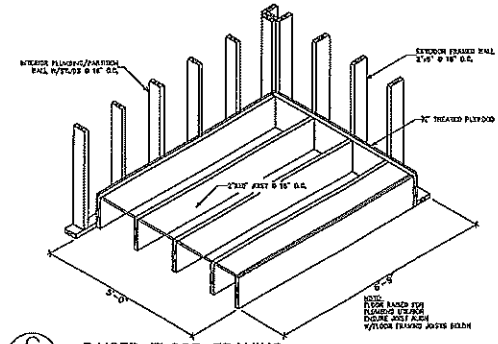

G RAISED FLOOR FRAMING
SCALE 1/2"=1'-0"

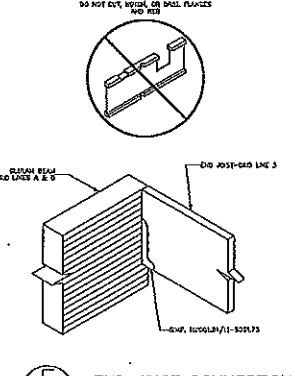

E END JOIST CONNECTION
SCALE 3/8"=1'-0"

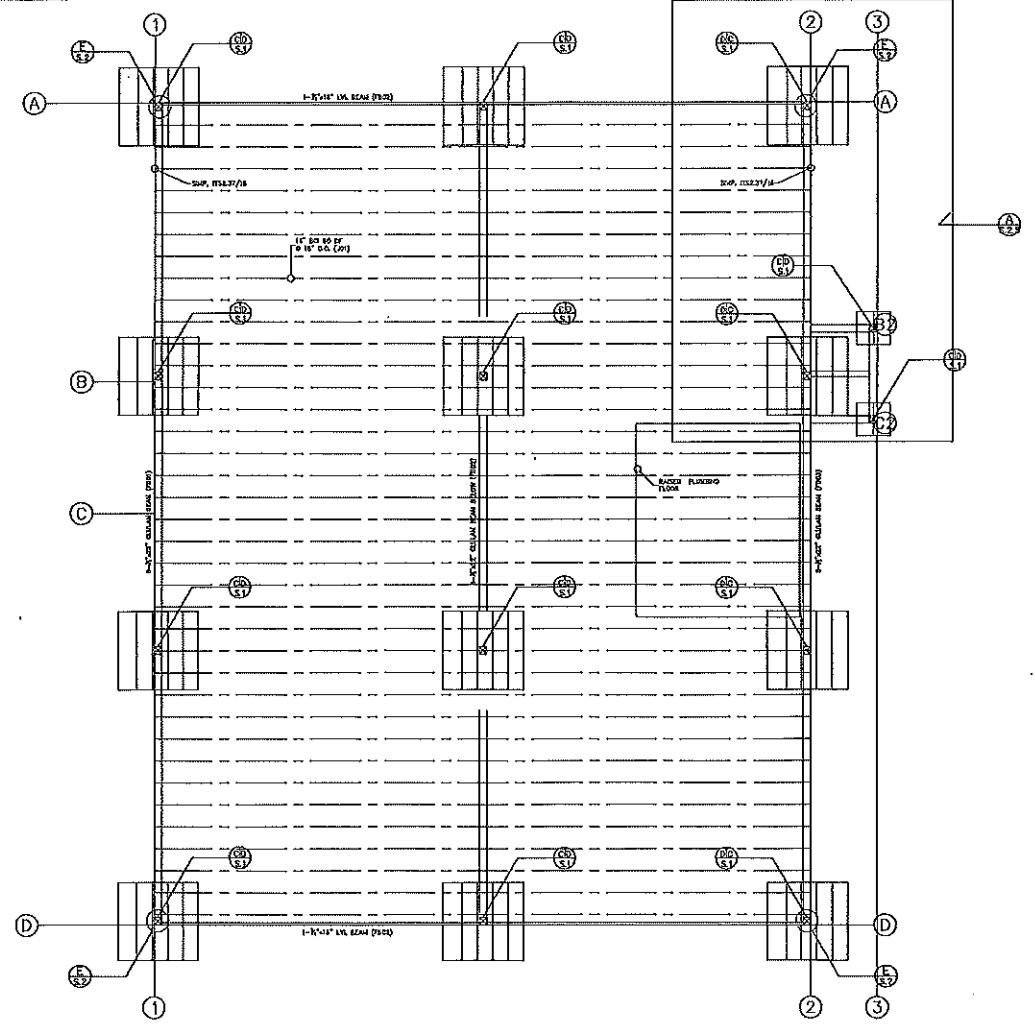

FRAMING PLAN
SCALE: 1/4"=1'-0"

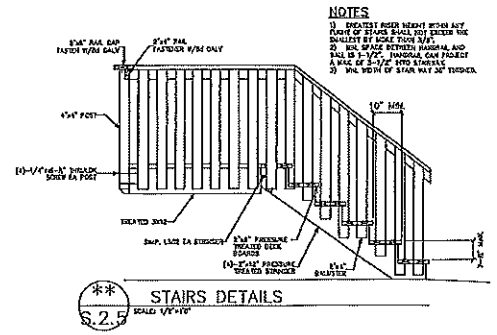

**** STAIRS DETAILS**
SCALE: 1/2\"/>

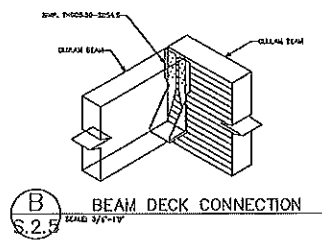

B BEAM DECK CONNECTION
SCALE: 3/4\"/>

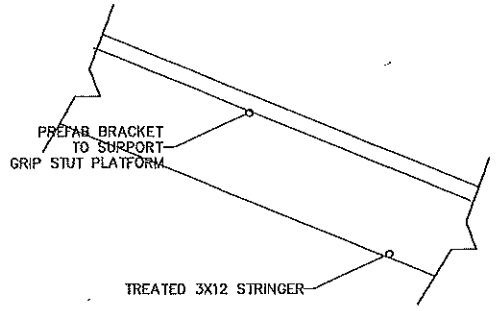

A GRIP STRUT SUPPORT DETAIL
SCALE: 1/2\"/>

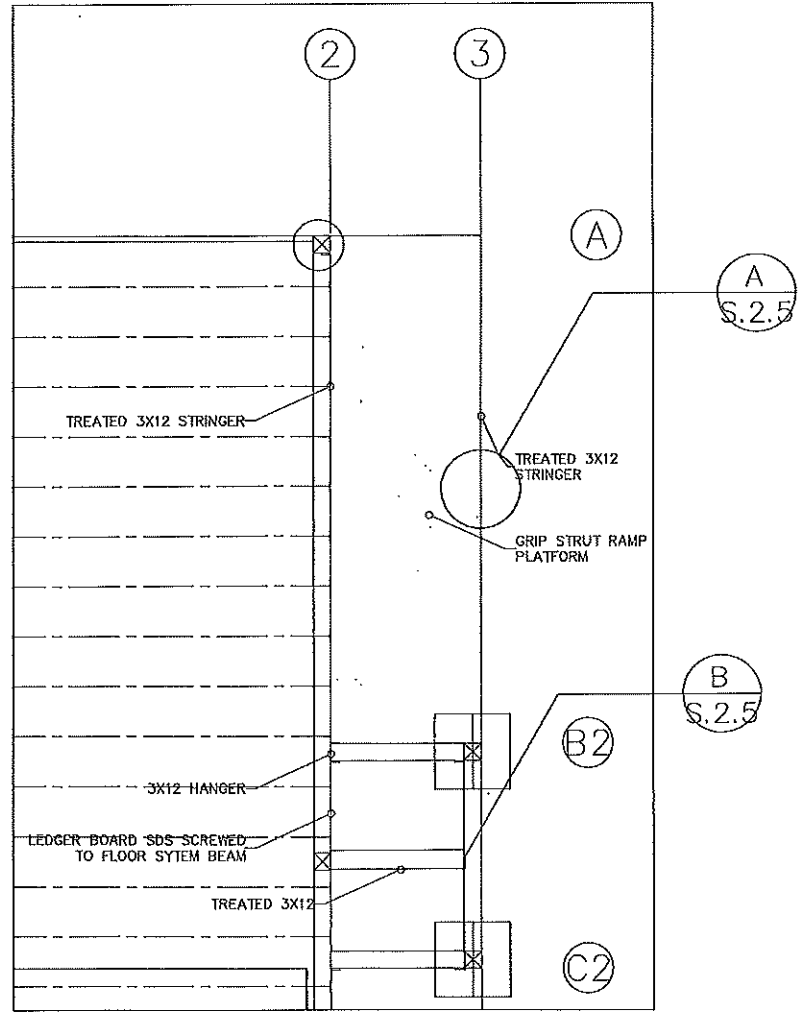

RAMP DETAIL
SCALE: NTS

ROW	TRUSS ROOF	ROOF TRUSS	SPACING
1	TRUSS - 24' P.P.	2x4	24' O.C.
	TRUSS - 18' P.P.	2x4	18' O.C.
	TRUSS - 12' P.P.	2x4	12' O.C.
2	TRUSS - 24' P.P.	2x4	24' O.C.
	TRUSS - 18' P.P.	2x4	18' O.C.
	TRUSS - 12' P.P.	2x4	12' O.C.
3	TRUSS - 24' P.P.	2x4	24' O.C.
	TRUSS - 18' P.P.	2x4	18' O.C.
	TRUSS - 12' P.P.	2x4	12' O.C.
4	TRUSS - 24' P.P.	2x4	24' O.C.
	TRUSS - 18' P.P.	2x4	18' O.C.
	TRUSS - 12' P.P.	2x4	12' O.C.

EM = EDGE MEMBER
 DM = EDGE MEMBER
 FM = FIELD MEMBER

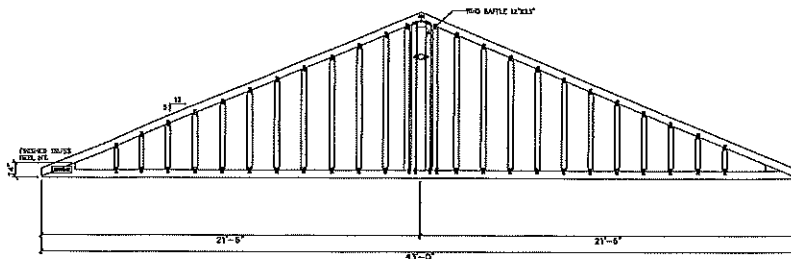

TRUSS TYPE A01
 SCALE: 1/4"=1'-0"

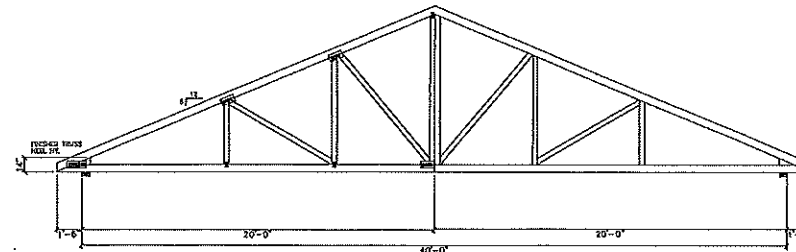

TRUSS TYPE A02
 SCALE: 1/4"=1'-0"

TRUSS FRAMING NOTES

- TRUSS LAYOUT SHOWN FOR DESIGN REFERENCE ONLY - SEE MANUFACTURER'S SPEC.
- TRUSS TYPE, TRUSS BRACING SHALL BE CORP. 2x4 @ 12' O.C. WITH 1/2" DIA. BOLTS FOR CONNECTIONS.
- ALL TRUSS MEMBERS SHALL BE 2x4 WITH SOLID ENDGRAIN OR BETTER. ALL TRUSS BRACING TO HAVE A MIN. OF 2" X 4" WITH SOLID ENDGRAIN OR BETTER.
- DETAILS OF THE TRUSS MANUFACTURING PROCESS SHALL BE PROVIDED IN ACCORDANCE WITH THE MANUFACTURER'S SPECIFICATIONS. THESE BRACING DETAIL SHALL BE APPROVED BY THE ARCHITECT PRIOR TO CONSTRUCTION. APPROVED BRACING DETAIL SHALL BE USED FOR ALL TRUSS BRACING. APPROVED BRACING DETAIL SHALL BE USED FOR ALL TRUSS BRACING.

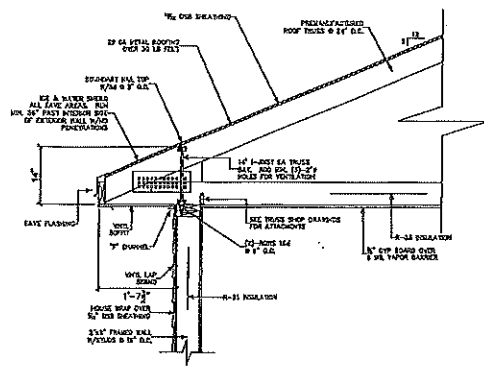

A
 S.3
 SCALE: 3/4"=1'-0"

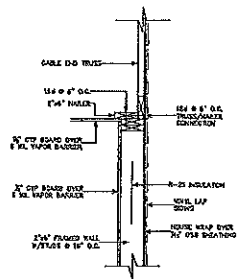

B
 S.3
 SCALE: 3/4"=1'-0"

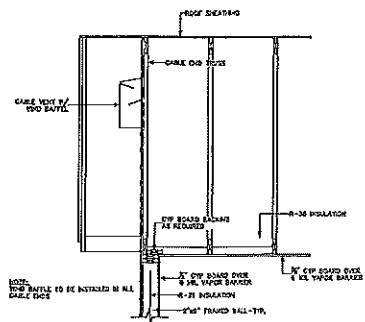

C
 S.3
 SCALE: 1/2"=1'-0"

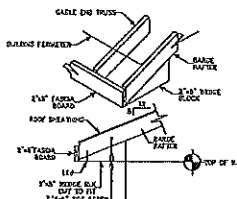

D
 S.3
 SCALE: 1/2"=1'-0"

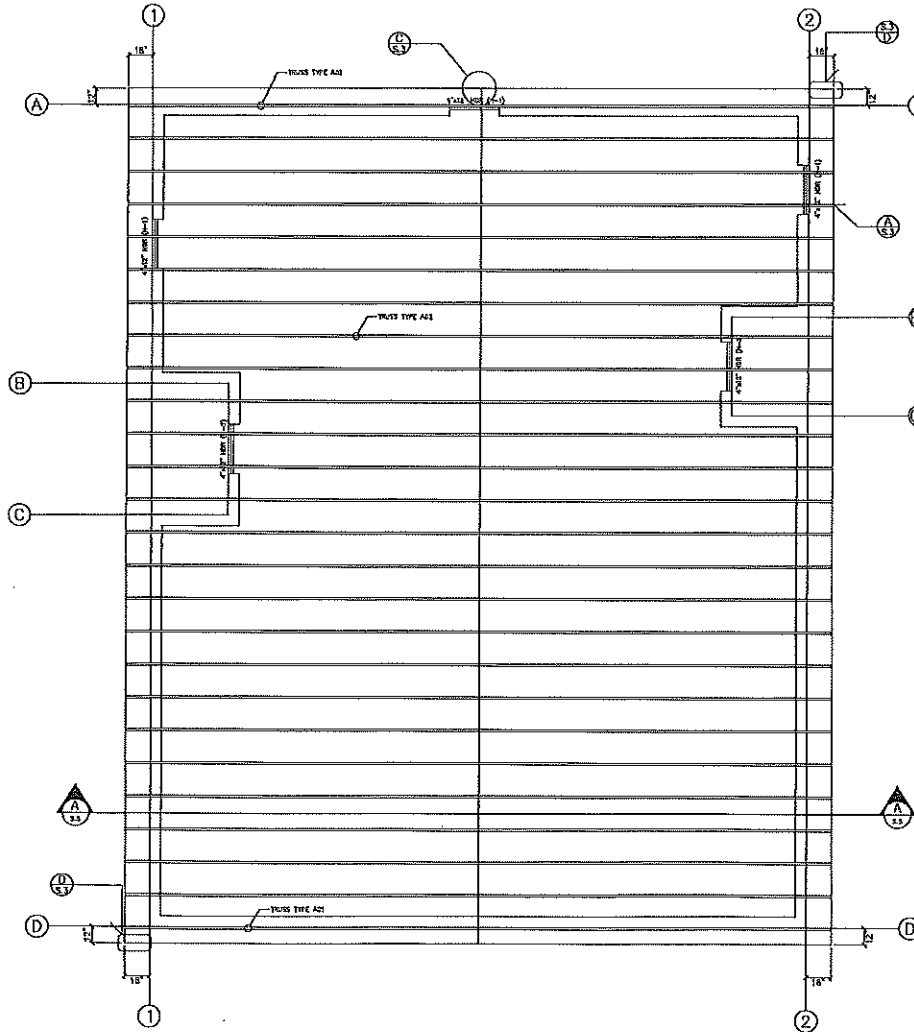

ROOF FRAMING PLAN
 SCALE: 1/4"=1'-0"

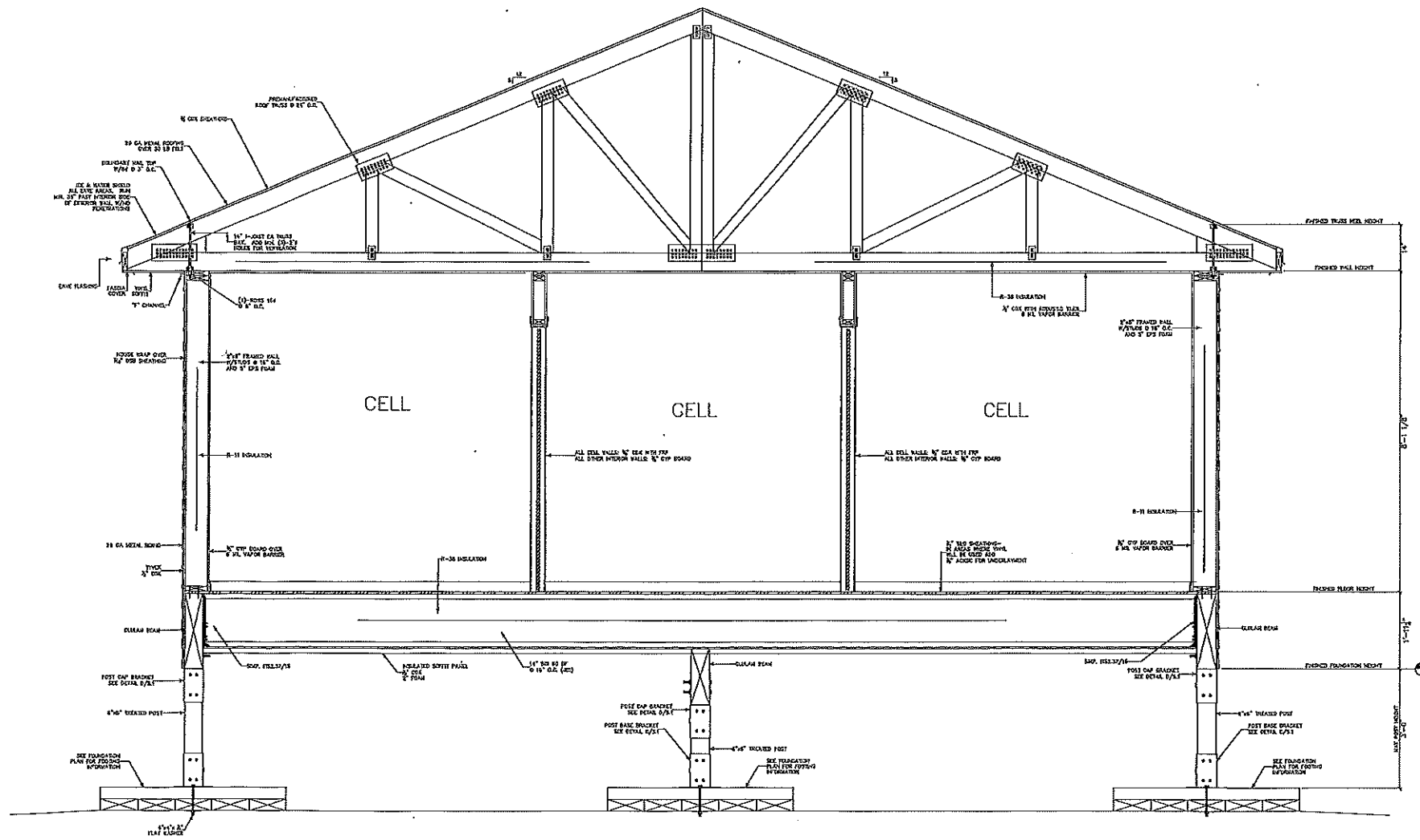

CROSS SECTION
 SCALE: 3/4"=1'-0"

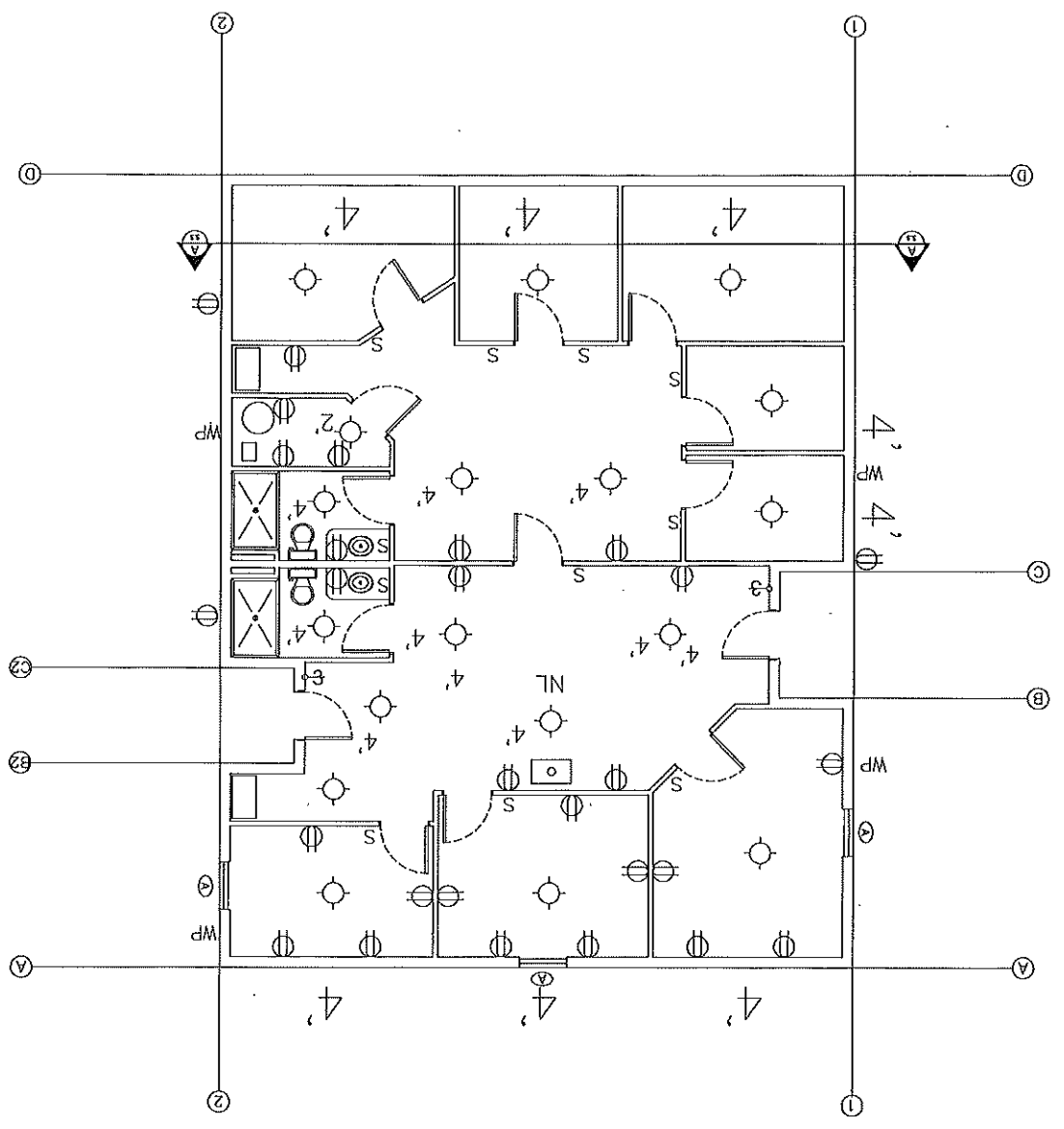

**APPENDIX C
BUY AMERICA CERTIFICATION**

Project Name: AVCP Alakanuk VPSO Building 2023 Material Order

The undersigned Bidder hereby certifies on behalf of itself and all contractors (at all tiers) that it will meet Buy America requirements in 23 CFR 635.410, using one of the following provisions:

- The product contains no steel or iron products manufactured outside the United States.** To be considered domestic, all steel and iron used and all products manufactured from steel and iron must be produced in the United States and all manufacturing processes, including application of a coating, for these materials must occur in the United States. Coating includes all processes that protect or enhance the value of the material to which the coating is applied. The Buy America process does not apply to this project. If there is ANY foreign steel or iron in your product you may not check this box.

- The product has minimal use of steel or iron products manufactured outside the United States.** The Buy America regulation does “not prevent a minimal use of foreign steel and iron materials, if the cost of such materials used does not exceed one-tenth of one percent (0.1 percent) of the total contract cost or \$2,500, whichever is greater. For purposes of this paragraph, the cost is that shown to be the value of the steel and iron products as they are delivered to the project. If this minimal use clause applies to your project, then please provide documentation indicating that this requirement is being met. The Buy America process does not apply to your project.

- The product meets the standards for the FHWA Manufactured Products waiver.** FHWA policy provides for a Buy America waiver for certain manufactured products. To be eligible for the Manufactured Products waiver, the product must consist of less than 90% steel or iron content when it is delivered to the job site for installation. If your product meets this manufactured products definition, please provide documentation of how the product is a manufactured product and submit for approval.

- The product has foreign steel or iron; a Buy America waiver is required.** Bidder certifies that it will comply with the applicable Buy America requirements if a waiver of those requirements is not available or not pursued by the Department. The waiver process can take time and the project may not move forward until a waiver is completed.

A false certification is a criminal act in violation of 18 USC 1001. Should this Agreement be investigated, Proposer has the burden of proof to establish that it is in compliance.

Proposer

Signature of Authorized Official

Name of Authorized Official

Title

Date

APPENDIX D
INSURANCE AND FINANCIAL RESPONSIBILITY REQUIREMENTS

The Respondent shall provide proof and maintain, at its own expense, acceptable evidence of financial responsibility (insurance, fully funded self-insurance, financial guarantee bond, cash bond, or letter of credit) with the following terms and conditions:

I. Commercial General Liability:

Coverage shall be at least as broad as ISO form CG 00 01 (Edition 12 04)

Limits: \$1,000,000 Combined Single Limit for Bodily Injury and Property Damage per Occurrence
\$2,000,000 Combined Single Limit for Bodily Injury and Property Damage Aggregate General
aggregate limits shall apply separately to each project and will cover liability for:

Per Project Aggregate

- a. Premises/Operations;
- b. Products/Completed Operations;
- c. Primary & Noncontributory with respect to Contractor's work;
- d. Contractual Liability (liability assumed under an insured contract);
- e. Independent Contractors;

General liability insurance shall be maintained in effect until final acceptance of the completed construction and, for products liability and completed operations liability at least two years thereafter.

If the general liability insurance is written on a claims-made form, the Contractor shall provide insurance for a period of two years after final payment of this agreement. The policy(s) shall evidence a retroactive date no later than the effective date of this contract.

If the Contractor utilizes a subcontractor(s) to perform any part of the work under this contract, the general liability insurance shall not contain any endorsements that exclude the work of the subcontractor(s).

II. Automobile Liability, to include the following coverages:

- a. Owned auto liability;
- b. Non-owned auto liability;
- c. Hired auto liability (when applicable);
- d. Limit: Not less than \$1,000,000 bodily injury and property damage combined single limit.

III. Workers' Compensation and Employer's Liability:

Limits: Workers' Compensation -Statutory coverage in the state work is being performed.

Employer's Liability: Bodily Injury by Accident - \$1,000,000 each accident
Bodily Injury by Disease - \$1,000,000 each employee Bodily Injury by Disease -
\$1,000,000 policy limit
Organizations using volunteer labor will provide evidence of coverage for
volunteers.

If the work is being performed on or about navigable water, the policy will be endorsed to include, if applicable:

United States Longshoreman and Harbor Workers Compensation Act Endorsement
Outer Continental Shelf Act Endorsement;
Maritime Employers' Liability Coverage Endorsement including coverage for transportation,
wages, maintenance and cure;
Maritime Voluntary Compensation Endorsement Borrowed Servant or Alternate Employer
Endorsement In Rem Endorsement.

IV. Crime/Employee Dishonesty Liability:

APPENDIX D
INSURANCE AND FINANCIAL RESPONSIBILITY REQUIREMENTS
PAGE 2 OF 3

STRONGLY RECOMMENDED (however not required)
Limit: Not less than \$500,000 per incident.

V. Umbrella/Excess Liability:

STRONGLY RECOMMENDED
Limit: Not less than \$5,000,000 per occurrence.

MINIMUM REQUIRED
Limit: Not less than \$2,000,000 per occurrence.

VI. Marine Comprehensive General Liability:

For any work involving maritime or offshore work, Contractor must carry Marine Comprehensive General Liability to include coverage for:

Contractual liability Independent Contractors Products/Completed Operations
Explosion, collapse and underground hazards

Limit: \$1,000,000 Combined Single Limit for Bodily Injury & Property Damage Per Occurrence
\$3,000,000 Combined Single Limit for Bodily & Property Damage Aggregate

VII. Cargo Marine Liability:

All Materials products will be insured for property coverage for the determined value at the time of the waterborne shipment.

Additional Insured Endorsements

The Respondent's insurer(s) will endorse all policies (except Workers' Compensation) to name The Association of Village Council Presidents as an Additional Insured.

Waiver of Subrogation Endorsements

The Respondent's insurer(s) will endorse all policies with a waiver of subrogation in favor of The Association of Village Council Presidents.

General Requirements

- a) All policies (except Workers' Compensation/Employer's Liability) must be endorsed to reflect that this coverage is primary and non-contributory as respects AVCP.
- b) No required coverage may be cancelled, materially changed, or non-renewed, without 30 days prior written notification to AVCP.
- c) Any sub-Contractor(s) will provide coverages at least equal to those required of the Respondent.
- d) Insurer(s) must be filed with the State of Alaska to write insurance business on an admitted basis.
- e) Insurer(s) must be rated at least "A-, VII" or better by A.M. Best.
- f) All coverages shall remain in effect until the completion of the contract.
- g) The Respondent shall provide a certificate or copies of documents evidencing all required coverages, prior to beginning work under any contract resulting from this Request for Proposals.

The Respondent shall file with the contract administrator within five days after date of contract, all financial responsibility to documentation previously mentioned.

VIII. Respondent Fidelity

Respondent shall be responsible for the conduct of their employees at any and all times. Should any of Respondent's employees steal any property owned by AVCP, property owned by others but in the care, custody and control of AVCP, or any negotiable instrument, Contractor shall be responsible to AVCP for the value of the stolen property.

IX. Contingency Plan Documentation

The Respondent shall provide proof and maintain, at its own expense, a Contingency Plan/Emergency Preparedness Plan. This plan should encompass any and all situations that may adversely affect the contracting company's ability to continue to supply service to AVCP.